

**TECHNICAL GUIDELINE**

**GUIDELINES FOR THE DESIGN OF  
ANCHORS AND THRUST BLOCKS ON  
BURIED PIPELINES WITH  
UNRESTRAINED FLEXIBLE JOINTS  
AND FOR THE  
ANCHORAGE OF PIPES ON STEEP GRADES**



Issued by:                      Manager Engineering

Issue Date:                    10 May 2007

This document is copyright and all rights are reserved by SA Water. No part may be reproduced, copied or transmitted in any form or by any means without the express written permission of SA Water.

The information contained in these Guidelines is strictly for the private use of the intended recipient in relation to works or projects of SA Water.

These Guidelines have been prepared for SA Water's own internal use and SA Water makes no representation as to the quality, accuracy or suitability of the information for any other purpose.

It is the responsibility of the users of these Guidelines to ensure that the application of information is appropriate and that any designs based on these Guidelines are fit for SA Water's purposes and comply with all relevant Australian Standards, Acts and regulations. Users of these Guidelines accept sole responsibility for interpretation and use of the information contained in these Guidelines.

SA Water and its officers accept no liability for any loss or damage caused by reliance on these Guidelines whether caused by error, omission, misdirection, misstatement, misinterpretation or negligence of SA Water.

Users should independently verify the accuracy, fitness for purpose and application of information contained in these Guidelines.

The currency of these Guidelines should be checked prior to use.

## Major Changes Incorporated In the May 2007 Edition

---

1. The following lists the major changes to the May 2007 edition of TG 96:Section 2.5 - Restrained Joints, additional dot point, plus the inclusion of Disadvantages/Issue in this section.
2. Section 6 – Corrosion Requirements, changes made to paragraph 6.2.
3. Section 4.2, 4.3, 4.4 & 4.5 numeric value in the formula has been changed.

 SA Water PLANNING & INFRASTRUCTURE	TG96 - Design of Pipe Anchorages.docx Issued by: Manager Engineering	10 May 2007 Uncontrolled on printing	Page 2 of 26
---------------------------------------------------------------------------------------------------------------------------	-------------------------------------------------------------------------	-----------------------------------------	-----------------

# Contents

---

© SA WATER 2007.....	2
<b>MAJOR CHANGES INCORPORATED IN THE MAY 2007 EDITION .....</b>	<b>2</b>
<b>SECTION 1: SCOPE.....</b>	<b>5</b>
<b>SECTION 2: DEFINITIONS.....</b>	<b>5</b>
2.1 UNRESTRAINED FLEXIBLE JOINT.....	5
2.2 PIPE SPECIAL .....	6
2.3 ANCHOR BLOCK.....	6
2.4 THRUST BLOCK.....	6
2.5 RESTRAINED JOINTS.....	7
<b>SECTION 3: GEOTECHNICAL.....</b>	<b>8</b>
3.1 GEOTECHNICAL DESIGN PRINCIPLES.....	9
3.2 GEOTECHNICAL ASSESSMENT OF EACH LOCATION.....	9
3.3 CONSTRAINTS ON ANCHOR AND THRUST BLOCK LOCATION.....	10
3.4 ALLOWABLE HORIZONTAL BEARING PRESSURES.....	10
<b>SECTION 4: DESIGN OF ANCHORS &amp; THRUST BLOCKS .....</b>	<b>13</b>
4.1 DESIGN HEAD.....	13
4.2 THRUST BLOCKS AT BENDS.....	13
4.3 THRUST BLOCKS AT TEES AND DEAD ENDS.....	14
4.4 ANCHOR BLOCKS AT TAPERS AND REDUCERS.....	15
4.5 ANCHOR BLOCKS AT VALVES AND TEMPORARY DEAD ENDS .....	16
4.6 PREPARATION OF DRAWINGS FOR ANCHORS AND THRUST BLOCKS.....	17
<b>SECTION 5: THRUST COLLARS AND PUDDLE FLANGES.....</b>	<b>18</b>
5.1 THRUST COLLARS AT ANCHORS ON MSCL PIPELINES .....	18
5.2 PUDDLE FLANGES AT ANCHORS ON DICL PIPELINES.....	18
<b>SECTION 6: CORROSION REQUIREMENTS .....</b>	<b>18</b>

6.1	CORROSION REQUIREMENTS ON MSCL PIPE SPECIALS.....	18
6.2	CORROSION REQUIREMENTS ON DICL PUDDLE FLANGES .....	19
	<b>SECTION 7: PIPE ANCHORAGE ON STEEP GRADE .....</b>	<b>19</b>
7.1	PIPE ANCHORAGE ON GRADES LESS THAN 20%.....	19
7.2	PIPE ANCHORAGE ON GRADES BETWEEN 20% AND 25% .....	19
7.3	PIPE ANCHORAGE ON GRADES STEEPER THAN 25% .....	21
	<b>APPENDIX A: DRAWINGS.....</b>	<b>24</b>

## Tables & Figures

---

Table 3.1 - Allowable Horizontal Bearing Pressures for Anchors and Thrust Blocks.....	11
Figure 7.1 - Pipe Anchorage on Grades between 20% and 25%.....	20
Figure 7.2 Pipe Anchorage on Grades Steeper than 25%.....	22
Figure 7.3 - Pipe Anchorage on Grades Steeper than 25%.....	23

## Referenced Documents

---

TS 4b

TS 81

Standard Drawing 75 2A

Drawing 98-0021-01

Transport SA specification SA10-7

 PLANNING & INFRASTRUCTURE	TG96 - Design of Pipe Anchorages.docx Issued by: Manager Engineering	10 May 2007 Uncontrolled on printing	Page 4 of 26
------------------------------------------------------------------------------------------------------------------	-------------------------------------------------------------------------	-----------------------------------------	-----------------

# Section 1: Scope

---

This document outlines the general requirements, as currently preferred by SA Water, for the design of *conventional* anchor blocks and thrust blocks on buried pipelines with unrestrained flexible joints.

Also covered are the requirements for the anchorage of buried pipelines with unrestrained flexible joints when they are laid on steep grades.

This document does not provide guidance for situations where soil conditions or site constraints are such that *non-conventional* anchors or thrust blocks are required on buried pipelines with unrestrained flexible joints. These will require individual engineering investigation and design to suit the particular circumstances.

Nor does it provide guidance for the design of anchors or thrust blocks for buried *rigid* pipelines (where temperature forces might need to be accommodated), or for any type of aboveground pipeline.

# Section 2: Definitions

---

## 2.1 UNRESTRAINED FLEXIBLE JOINT

The typical “unrestrained flexible joint” used on SA Water pipelines is a spigot and socket joint that includes a captive compressed rubber ring in the joint to prevent leakage. It is therefore known as a “rubber ring joint” or “RRJ”. Clearly a rubber ring joint of this construction has no significant ability to resist being pulled apart – hence the term “unrestrained”.

Rubber ring joints are also usually designed with the socket somewhat larger than is absolutely necessary to enable the joint to be assembled. This allows the joint to be flexed a little after assembly, or even laid with a small permanent

angular deflection at each joint so that the pipeline can be made to follow a gentle curve.

## 2.2 PIPE SPECIAL

A **pipe special** is any specially fabricated or precast piece of pipe. In the context of anchor and thrust block design, a pipe special will usually be a bend, taper, tee, stop end, or a flanged length of pipe bolted to a valve.

On a pipeline with unrestrained flexible joints, a pipe special will normally need to be restrained using an anchor or a thrust block.

## 2.3 ANCHOR BLOCK

A conventional **anchor block** is a reinforced concrete block which is cast around a straight piece of pipe, and which is designed to restrain the pipe against longitudinal movement. Refer to Drawing 98-0021-01.

The longitudinal thrust from the pipe is transferred into the anchor block via a puddle flange clamped onto the pipe (for DICL pipes) or via a thrust collar welded to the pipe (for MSCL pipes).

The anchor block is cast into slots cut into the trench wall so as to transfer the thrust into undisturbed native soil.

Anchor blocks will normally only be used at in-line valves or tapers, where it is not possible to use the much simpler “thrust block”.

## 2.4 THRUST BLOCK

A **thrust block** is a simple unreinforced block of concrete cast against, rather than around, the pipe special.

A conventional thrust block at a **horizontal bend or tee** would be a concrete block designed to transfer the thrust from the pipe into the undisturbed native soil

 PLANNING & INFRASTRUCTURE	TG96 - Design of Pipe Anchorages.docx Issued by: Manager Engineering	10 May 2007 Uncontrolled on printing	Page 6 of 26
------------------------------------------------------------------------------------------------------------------	-------------------------------------------------------------------------	-----------------------------------------	-----------------

in the trench wall.

A conventional thrust block at a **vertical bend** (downward thrust) would be similar to that for a horizontal bend, but would bear on the trench floor rather than the wall.

A conventional thrust block at a **vertical bend** (upward thrust) is simply a block of concrete attached to the pipe with sufficient weight to counterbalance the thrust.

Note that an anchor block can be used instead of a thrust block. For example, the branch of a tee could be extended and an anchor placed on the branch, or both legs of a bend could be extended and an anchor placed on each leg. But because of the extra cost, anchor blocks would only be used instead of thrust blocks where conditions at the bend precluded the use of a thrust block there - eg conflict with other services, weak natural soils, disturbed soils, or the presence of cross trenches.

## 2.5 RESTRAINED JOINTS

A “restrained joint” is a usually conventional flexible rubber ring joint that is restrained against pullout and angular deflection by the inclusion of a (proprietary) metal “claw” device in the rubber ring. An example is the Tyton-Lok system used on Tyton Ductile Iron pipes. Restrained joints are available only for RRJ Ductile Iron Cement (mortar) Lined (**DICL**) pipes and fittings, and then only for pipes in the size range of 100 to 300 mm nominal diameter. Restrained joints do not work in compression.

Restrained joints can be used either to create a complete “restrained joint anchorage system” (as an alternative to concrete anchors or thrust blocks) or they can be used in association with concrete anchors or thrust blocks.

Some of the benefits of restrained joint anchorage systems on **DICL** pipelines are:

- No concrete is required. This is convenient in areas where the logistics of providing concrete is difficult.

 SA Water PLANNING & INFRASTRUCTURE	TG96 - Design of Pipe Anchorages.docx Issued by: Manager Engineering	10 May 2007 Uncontrolled on printing	Page 7 of 26
---------------------------------------------------------------------------------------------------------------------------	-------------------------------------------------------------------------	-----------------------------------------	-----------------

- They occupy no space outside of the pipe trench. This is convenient where space is at a premium in congested service corridors, or where future interference by other utilities can be anticipated.
- The pipeline can be pressure tested and put into service immediately – no curing time is required for concrete anchors or thrust blocks. This is convenient when the commissioning of the pipeline is urgent.
- A “complete system” of restrained joints can be used *instead of* conventional concrete anchors or thrust blocks where there is no satisfactory ground within a reasonable distance.
- A “short run” of restrained joints can be used *in association with* conventional concrete anchors or thrust blocks. This might be useful for example where the ground at the desired location is unsatisfactory but there is good ground a short distance away, or where other trenches or services would otherwise be in the thrust zone of an anchor or thrust block.
- Manufacturers can specify a minimum length of buried pipe with restrained joints to provide restraint for a tee or bend etc.

#### Disadvantages/Issues

- Cut-ins difficult
  - Must be marked as restrained to prevent incorrect repair procedure.
  - Locking gasket may only be used in pipe recommended by manufacturer.
- Incompatibility problems.

Restrained joint anchorage system design software is available from some manufacturers, but the design models used in that software do not always appear to follow conventional geotechnical or structural engineering principles rigorously.

Because of this, and because most manufacturers offer a free design service for complete restrained joint anchorage systems, and also because such designs usually come with a warranty, it is recommended that in general a manufacturer’s design be requested and adopted.

## Section 3: Geotechnical

---

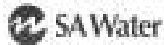
 PLANNING & INFRASTRUCTURE	TG96 - Design of Pipe Anchorages.docx Issued by: Manager Engineering	10 May 2007 Uncontrolled on printing	Page 8 of 26
------------------------------------------------------------------------------------------------------------------	-------------------------------------------------------------------------	-----------------------------------------	-----------------



### 3.1 GEOTECHNICAL DESIGN PRINCIPLES

An anchor or thrust block must be designed to transfer the thrust from the pipe ONLY into the undisturbed native soil in the trench wall. On no account should the pipe embedment be relied upon to resist any of the thrust. There are three main reasons for this:

- (1) It is generally impossible to compact embedment material (or any other material) sufficiently densely against an anchor or thrust block to eliminate any bedding-in movement. (Trials have shown that bedding-in movement can easily be 5 mm or so, which may be half of the total permissible movement.)
- (2) It is possible that the trench fill material will not have been placed when the pressure test is carried out. If so, the pipe embedment material would have no surcharge load on it and therefore could not resist any horizontal force.
- (3) The natural material is likely to have a much higher stiffness modulus than the embedment material, and will therefore attract most of the thrust anyway.

The designer should also be aware that in most pipe networks it is likely that the thrust on a valve etc could come from either direction. The designer should therefore specify that BOTH faces of an anchor block must be poured against undisturbed native soil.

### 3.2 GEOTECHNICAL ASSESSMENT OF EACH LOCATION

Soil conditions, particularly at the shallow depths at which anchors and thrust blocks are usually set, can vary enormously over short distances, as a study of almost any road cutting or trench wall will reveal.

 PLANNING & INFRASTRUCTURE	TG96 - Design of Pipe Anchorages.docx Issued by: Manager Engineering	10 May 2007 Uncontrolled on printing	Page 9 of 26
------------------------------------------------------------------------------------------------------------------	-------------------------------------------------------------------------	-----------------------------------------	-----------------

The designer will therefore need to ascertain the allowable horizontal (or vertical) bearing capacity of the natural ground at each anchor or thrust block location.

In some areas this will mean an investigation of the exact location of each anchor or thrust block prior to commencing the design.

In other areas (eg the Adelaide metro area) it may be possible, once sufficient experience is gained in an area, to adopt a conservative design value for that area. Even so, each anchor or thrust block location should be checked by a trained person to ensure that the conditions are as assumed.

### 3.3 CONSTRAINTS ON ANCHOR AND THRUST BLOCK LOCATION

The designer should be aware that the proposed location of an anchor or thrust block might have other pipe or service trenches or other excavations close to it. If these trenches or excavations, whether open or backfilled, are within the zone of ground stressed by the bearing area of the anchor or thrust block, then they may compromise the effectiveness of the proposed block to resist the thrust without exceeding the allowable movement.

In such circumstances, it may be necessary to design the pipe special so that the anchor or thrust block is located well away from any cross trenches or other excavated areas or disturbed ground (eg by extending one leg or otherwise changing the configuration of the special). Alternatively, for DICL pipes up to 300 mm diameter, restrained joints may be used (Refer Section 2.5).

### 3.4 ALLOWABLE HORIZONTAL BEARING PRESSURES

The purpose of an anchor or thrust block is not simply to resist the force from the fitting, but for it to do so without the **movement** of the block exceeding the **allowable movement** at the pipe joints closest to the block. For example, a rubber ring joint on a 150 mm pipe may only be able to tolerate an extension of less than 10 mm.

The soil on which the block is bearing must therefore be judged not by its

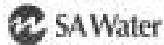
 PLANNING & INFRASTRUCTURE	TG96 - Design of Pipe Anchorages.docx Issued by: Manager Engineering	10 May 2007 Uncontrolled on printing	Page 10 of 26
------------------------------------------------------------------------------------------------------------------	-------------------------------------------------------------------------	-----------------------------------------	------------------

ultimate horizontal bearing capacity at “failure”, but by its load-deflection characteristics well below the failure stress. Note that the load-deflection characteristics of a soil are governed not so much by the soil type (ie whether it is a clay or a sandy soil) but by its density (if a sand) or its consistency (if a clay).

The assessment of the allowable horizontal bearing pressure clearly requires a geotechnical investigation at the exact location and considerable geotechnical experience. However, where ground conditions are reasonably good, and the thrusts are not large (eg pipe diameter is less than 300 mm), then it may be reasonable to use simple field identification tests, and to adopt conservative values for allowable horizontal bearing pressures. Examples of some simple field identification tests and conservative allowable horizontal bearing pressures are given in Table 1.

Note that for larger pipes (above 300 mm diameter) adopting a conservative value is likely to result in a very large anchor or thrust block, and so it is likely to prove more economical to investigate the ground conditions at each location.

It is clear from the foregoing discussion that there will be situations where the ground conditions are so poor that the *allowable movement* will be exceeded by any reasonably sized *conventional* anchor or thrust block. It is not within the scope of these guidelines to detail other options available to designers in such situations, but mention will be made of a few which could be considered, namely:

- (a) Using restrained joint anchorage systems (eg Tyton-Loc).
- (b) Pre-loading an anchor or thrust block using jacks (can only work in one direction).
- (c) Using piles or piers.
- (d) Using a welded “special” to transfer the thrust to a location where a conventional anchor or thrust block can be used.

Table 3.1 - Allowable Horizontal Bearing Pressures for Anchors and Thrust Blocks.

Trench Wall Material	Field Identification Test (1)	Allowable Horizontal Bearing Pressure (2)
----------------------	----------------------------------	----------------------------------------------------

<b>CLAYS</b>	Very Soft Clay	Easily penetrated 40 mm with fist	(3)
	Soft Clay	Easily penetrated 40 mm with thumb	(3)
	Firm Clay	Moderate effort needed to penetrate 30 mm with thumb	(3)
	Stiff Clay	Readily indented with thumb but penetrated only with great effort	50 kPa
	Very Stiff Clay	Readily indented by thumbnail	100 kPa
	Hard Clay	Indented with difficulty by thumbnail	200 kPa
<b>SANDS</b>	Loose Clean Sand	Takes footprint more than 10 mm deep	(3)
	Medium-Dense Clean Sand	Takes footprint 3 mm to 10 mm deep	50 kPa
	Dense Clean Sand or Gravel	Takes footprint less than 3 mm deep	100 kPa
<b>ROCK</b>	Broken or Decomposed Rock	Can be dug with pick. Hammer blow "thuds". Joints spaced less than 300 mm apart.	100 kPa
	Sound Rock	Too hard to dig with pick. Hammer blow "rings". Joints more than 300 mm apart.	200 kPa
<b>UNCOMPACTED FILL DOMESTIC REFUSE</b>		Visual inspection of the materials and/or a knowledge of the history of the site.	(3)

- (1) All field identification tests must be done on a freshly exposed, damp, hand-trimmed area of the trench wall by an engineer / technical officer competent in such work. Care must be taken to ensure that the soil in the test area was not compacted or loosened during the excavation. If the soil in the trench floor is very dry at the time the trench is opened, the test area must be flooded and time allowed for the water to be absorbed by the soil before trimming and testing.
- (2) For anchors and thrust blocks with the centre of thrust about 1 m below the surface as occurs with SA Water reticulation systems where normal cover to the pipe is 750 mm.

- (3) Standard values cannot be used - specialist geotechnical investigation and design required.

## Section 4: Design of Anchors & Thrust Blocks

---

### 4.1 DESIGN HEAD

The design head for anchor and thrust blocks will generally be the test pressure.

For SA Water reticulation systems the test pressure is 1.6 MPa (160 m head).

For water supply trunk mains, sewer rising mains, irrigation water supply mains, etc, the test pressure will be determined by the designer of the pipeline. The test pressure will generally be the operating pressure (including surge allowance) multiplied by an appropriate factor of safety.

### 4.2 THRUST BLOCKS AT BENDS

Thrust blocks at horizontal and vertical bends on buried pipelines with unrestrained flexible joints are designed to resist the total resultant hydraulic thrust. It is assumed that the block transmits all of the thrust into the adjacent native soil or rock only (ie not into the pipe embedment material or any compacted fill).

The thrust block should not protrude beyond the space allocation for the pipeline when located in a road reserve.

- i) For pipelines 100 to 300 mm in diameter, with a test pressure not in excess of 1.6 MPa (160 m head), thrust blocks as shown on the appropriate Water Construction Manual Drawings may be used. Note that the size of the thrust block in these drawings is determined on the basis that the pipe is laid at the minimum cover.
- ii) For pipelines with test pressures exceeding 1.6 MPa, and all pipelines 375

 SA Water PLANNING & INFRASTRUCTURE	TG96 - Design of Pipe Anchorages.docx Issued by: Manager Engineering	10 May 2007 Uncontrolled on printing	Page 13 of 26
---------------------------------------------------------------------------------------------------------------------------	-------------------------------------------------------------------------	-----------------------------------------	------------------

mm in diameter or greater, the following formula may be used to calculate the resultant thrust at a bend:

$$T = 1.54 \times 10^{-5} \times h \times d^2 \times \sin (\phi / 2)$$

where: T = resultant thrust in kN  
h = effective head in metres  
d = outside diameter of pipe (mm)  
 $\phi$  = deflection angle of bend in degrees

Note that the resultant thrust bisects the angle of the bend. A long lobster-back bend may need to be considered as two separate bends (ie with two thrust blocks, one at each end) to avoid bending stresses in the pipe between the ends of the lobster-back.

#### 4.3 THRUST BLOCKS AT TEES AND DEAD ENDS

Thrust blocks at tees and dead ends on buried pipelines with unrestrained flexible joints are designed to resist the total hydraulic thrust. It is assumed that the thrust block transmits all of the thrust into the adjacent native soil or rock only (ie not into the pipe embedment material or any compacted fill).

The thrust block should not protrude beyond the space allocation for the pipeline when located in a road reserve.

- i) For pipelines 100 to 300 mm in diameter, with a test pressure not in excess of 1.6 MPa (160 m head), thrust blocks as shown on the appropriate Water Construction Manual Drawings may be used. Note that the size of the thrust blocks in these drawings is determined on the basis that the pipe is laid at minimum cover and with the minimum allowable trench width.
- ii) For pipelines with test pressures exceeding 1.6 MPa, and all pipelines 375 mm in diameter and greater, the following formula may be used to calculate the thrust at a tee or dead end:

 PLANNING & INFRASTRUCTURE	TG96 - Design of Pipe Anchorages.docx Issued by: Manager Engineering	10 May 2007 Uncontrolled on printing	Page 14 of 26
------------------------------------------------------------------------------------------------------------------	-------------------------------------------------------------------------	-----------------------------------------	------------------

$$T = 0.77 \times 10^{-5} \times h \times d^2$$

where: T = resultant thrust in kN  
h = effective head in metres  
d = outside diameter of pipe (mm)

Note that the thrust acts axially along the line of the branch at a tee, and axially along the pipe at a dead end.

#### 4.4 ANCHOR BLOCKS AT TAPERS AND REDUCERS

Anchor blocks at tapers and reducers on buried pipelines with unrestrained flexible joints are designed to resist the total hydraulic thrust. It is assumed that the thrust is transmitted to the anchor block via a thrust ring (MSCL) or puddle flange (DICL) and then from the anchor block into the adjacent native soil or rock only (ie never into the pipe embedment material or any compacted fill).

The preferred design model is indicated on Drawing 98-0021-01 - Concrete Anchor Blocks - Structural Design Requirements.

 SA Water PLANNING & INFRASTRUCTURE	TG96 - Design of Pipe Anchorages.docx Issued by: Manager Engineering	10 May 2007 Uncontrolled on printing	Page 15 of 26
---------------------------------------------------------------------------------------------------------------------------	-------------------------------------------------------------------------	-----------------------------------------	------------------

The anchor block should not protrude beyond the space allocation for the pipeline when located in a road reserve.

- i) For tapers and reducers with the larger diameter between 100 and 375 mm, and with a test pressure not in excess of 1.6 MPa (160 m head), the anchor blocks shown on the appropriate Water Construction Manual Drawings may be used. Note that the size of the anchor blocks on these drawings is determined on the basis that the main is laid at minimum cover.
- ii) For pipelines with test pressures exceeding 1.6 MPa, and all tapers and reducers with the larger diameter greater than 375 mm, the following formula may be used to calculate the thrust:

$$T = 0.77 \times 10^{-5} \times h \times (D^2 - d^2)$$

where:

- T = resultant thrust in kN
- h = effective head in metres
- D = outside diameter of larger pipe (mm)
- d = outside diameter of smaller pipe (mm)

Note that the thrust always acts axially along the pipe in the direction from the larger diameter to the smaller irrespective of the direction of flow (friction forces are neglected).

The anchor is usually located on the larger diameter parallel-wall section of the taper or reducer.

#### 4.5 ANCHOR BLOCKS AT VALVES AND TEMPORARY DEAD ENDS

Anchor blocks at valves and temporary dead ends on buried pipelines with unrestrained flexible joints are designed by assuming that the total thrust is transmitted to the anchor block via a thrust ring or puddle flange, and then from the anchor block into native soil or rock. (Ie never into the pipe embedment material or any compacted fill.) The preferred design model is indicated on Drawing 98-0021-01.

 PLANNING & INFRASTRUCTURE	TG96 - Design of Pipe Anchorages.docx Issued by: Manager Engineering	10 May 2007 Uncontrolled on printing	Page 16 of 26
------------------------------------------------------------------------------------------------------------------	-------------------------------------------------------------------------	-----------------------------------------	------------------



Note that the anchor block should not protrude beyond the space allocation for the pipeline when located in a road reserve.

For pipes between 100 mm and 375 mm nominal diameter, and with a test pressure not in excess of 1.6 MPa (160 m head), the anchor blocks shown on the Water Construction Manual Drawings may be used. Note that the size of the anchor blocks on these drawings is determined on the assumption that the pipe is laid at minimum cover.

For pipelines with test pressures exceeding 1.6 MPa, and all pipes with a diameter greater than 375 mm, the following formula may be used to calculate the thrust at valves and temporary dead ends:

$$T = 0.77 \times 10^{-5} \times h \times D^2$$

where:

- T = resultant thrust in kN
- h = effective head in metres
- D = outside diameter of the pipe (mm)

Note that the thrust acts axially along the pipe, and should be considered likely to act in both directions, even for a valve at a temporary dead end.

#### **4.6 PREPARATION OF DRAWINGS FOR ANCHORS AND THRUST BLOCKS**

To avoid confusion on site, a single drawing should be prepared for each anchor or thrust block. Where reinforcement is present, its layout should be shown on the drawings. The use of a “typical” layout drawing with the dimensions and reinforcement details being given in an accompanying table is discouraged.

 PLANNING & INFRASTRUCTURE	TG96 - Design of Pipe Anchorages.docx Issued by: Manager Engineering	10 May 2007 Uncontrolled on printing	Page 17 of 26
------------------------------------------------------------------------------------------------------------------	-------------------------------------------------------------------------	-----------------------------------------	------------------

## Section 5: Thrust Collars and Puddle Flanges

---

### 5.1 THRUST COLLARS AT ANCHORS ON MSCL PIPELINES

On MSCL pipelines the longitudinal thrust in the pipe wall is transferred into the anchor block via welded-on thrust collars.

Design details are given on Standard Drawing 75 2A - Standard Thrust Collars for MSCL Pipelines (appended).

### 5.2 PUDDLE FLANGES AT ANCHORS ON DICL PIPELINES

On DICL pipelines the longitudinal thrust in the pipe wall is transferred into the anchor block via clamp-on pre-cast puddle flanges.

A groove is pre-milled into the wall of the pipe to locate the puddle flange. The pipe special is usually supplied by the manufacturer complete with its milled groove and puddle flange.

## Section 6: Corrosion Requirements

---

### 6.1 CORROSION REQUIREMENTS ON MSCL PIPE SPECIALS

**Anchor Blocks on MSCL Pipe Specials:** Standard thrust collars on MSCL specials at anchor blocks extend beyond the block so that they also act as sacrificial corrosion collars. No additional corrosion collar is necessary. Refer Drawing 75 2A.

 PLANNING & INFRASTRUCTURE	TG96 - Design of Pipe Anchorages.docx Issued by: Manager Engineering	10 May 2007 Uncontrolled on printing	Page 18 of 26
------------------------------------------------------------------------------------------------------------------	-------------------------------------------------------------------------	-----------------------------------------	------------------

**Thrust Blocks on MSCL Pipe Specials:** Where MSCL specials are protected by SintaKote, or are wrapped to TS81, the thrust block may be cast directly against the coating or wrapping. In aggressive ground, or where wrapping to TS81 is not proposed, a corrosion plate or saddle a minimum of 10 mm thick is required over the contact area of the thrust block and extending 150 mm beyond it all around.

## 6.2 CORROSION REQUIREMENTS ON DICL PUDDLE FLANGES

**Anchor Blocks on DICL Pipes with Puddle Flanges:** The anchor block is poured directly around the DICL pipe puddle flange. No wrapping or sleeving is required beneath the concrete. Normal pipe sleeving and wrapping is extended up to the block and denso petrolatum tape used to seal between the concrete and sleeving.

**Thrust Blocks on DICL Fittings:** The thrust block is poured directly against the sleeved DICL fitting. Note, all fusion bonded coated fittings at thrust blocks shall be sleeved with PE.

## Section 7: Pipe Anchorage on Steep Grade

---

### 7.1 PIPE ANCHORAGE ON GRADES LESS THAN 20%

No special anchorage or laying precautions are required where the grade is less than 20%. Normal embedment in TS4b sand, placed and compacted as detailed in the Water Supply Construction Manual, is sufficient in these situations.

### 7.2 PIPE ANCHORAGE ON GRADES BETWEEN 20% AND 25%

At grades steeper than 20% it becomes increasingly more difficult to handle, place and properly compact sand in the embedment zone. Also the downhill component of the pipe weight begins to become significant, and the tendency of embedment sand to creep downhill increases – particularly in the presence of percolating groundwater. Therefore on grades between 20% and 25%:

 SA Water PLANNING & INFRASTRUCTURE	TG96 - Design of Pipe Anchorages.docx Issued by: Manager Engineering	10 May 2007 Uncontrolled on printing	Page 19 of 26
---------------------------------------------------------------------------------------------------------------------------	-------------------------------------------------------------------------	-----------------------------------------	------------------

- Lay the pipes from the bottom of the hill to the top with the sockets facing uphill.
- Embed the pipes in 10-7 mm screenings to Transport SA specification SA10-7. (MPVC and OPVC pipe only, not UPVC, and with care on DICL sleeving.)
- Anchor each pipe length with an unreinforced concrete bulkhead behind each socket.
- Provide two 75 mm diameter holes through each bulkhead to allow groundwater to drain down the embedment.
- Cover the upstream end of each drain hole with a patch of non-woven geotextile or similar.
- Key the bulkheads into the trench walls 75 mm each side if in rock and 150 mm each side if in soil.

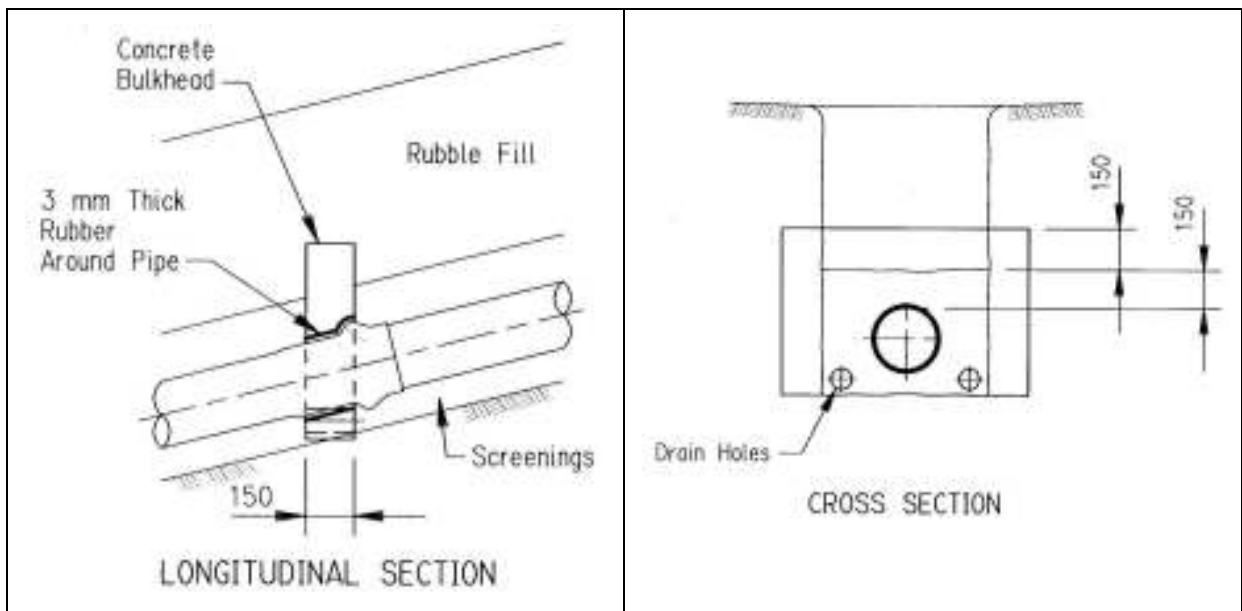
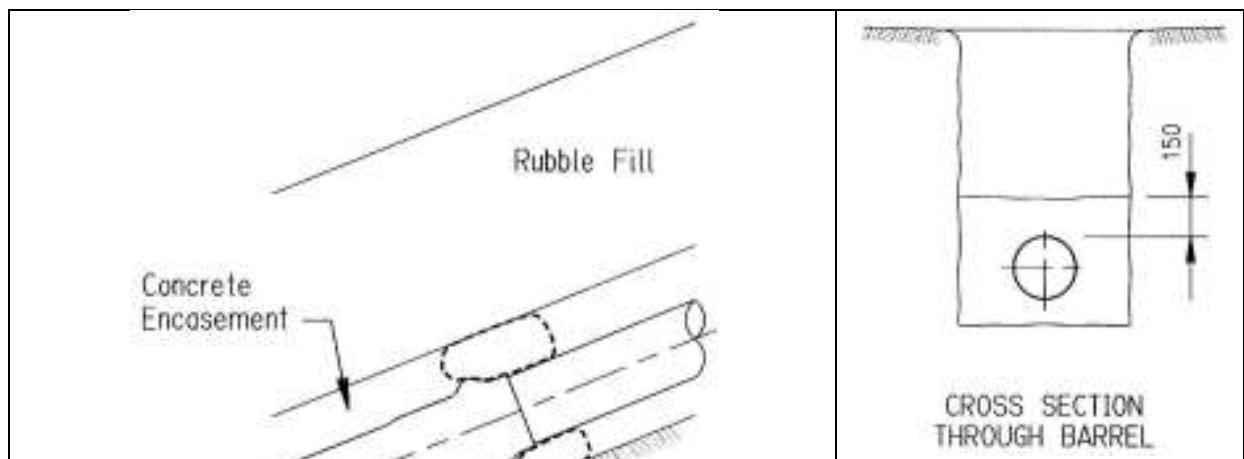

Figure 7.1 - Pipe Anchorage on Grades between 20% and 25%.

### 7.3 PIPE ANCHORAGE ON GRADES STEEPER THAN 25%

At grades steeper than 25% it becomes increasingly difficult to handle and place even screenings in the embedment zone. Also the downhill component of the pipe weight becomes very significant, and ultimately even screenings can begin to creep downhill. Therefore on grades steeper than 25%:

- Lay the pipes from the bottom of the hill to the top with the sockets facing uphill.
- Embed the full length of each pipe barrel in low-strength concrete that is workable enough to be pushed under the pipe without displacing it, or in sprayed concrete.
- Place sandbags around each flexible joint in the pipeline to maintain the flexibility of the joints (this will also assist with the containment of the concrete).
- If using poured concrete for the embedment, consider that it may need to be poured in layers to cope with the slope and/or to prevent the pipe becoming buoyant, and that it might also be necessary to ballast the pipe to prevent flotation. (Neither the slope nor buoyancy should be an issue if sprayed concrete is used.)
- Note that the natural roughness of the trench floor and walls will provide more than adequate shear interlock with the concrete.



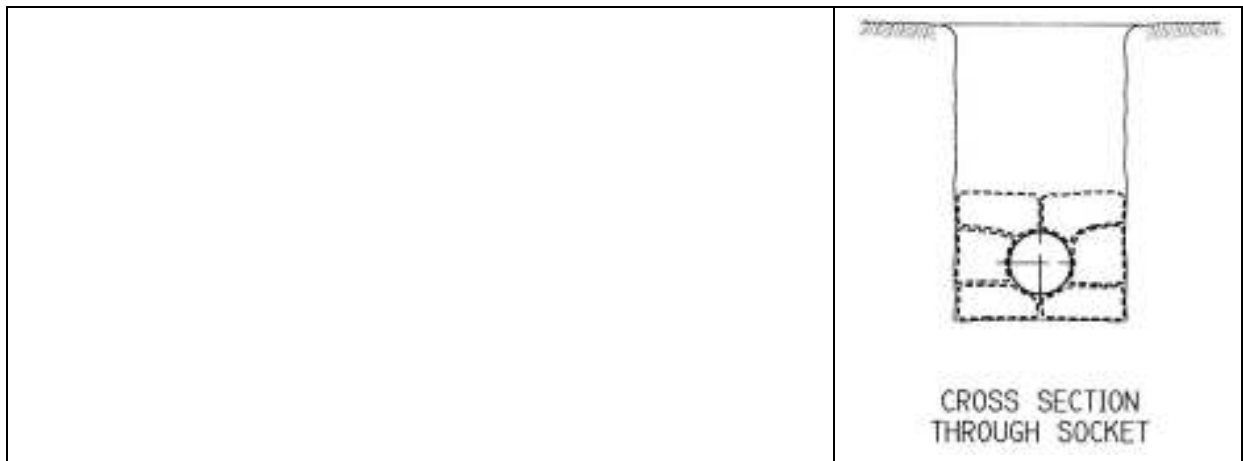

Figure 7.2 Pipe Anchorage on Grades Steeper than 25%.



	
<p>Spray concrete embedment being applied. Note it flowing under the pipe.</p>	<p>A view of the finished spray concrete embedment.</p>

Figure 7.3 - Pipe Anchorage on Grades Steeper than 25%.

Appendix A: Drawings

 SA Water PLANNING & INFRASTRUCTURE	TG96 - Design of Pipe Anchorages.docx Issued by: Manager Engineering	10 May 2007 Uncontrolled on printing	Page 24 of 26
---------------------------------------------------------------------------------------------------------------------------	-------------------------------------------------------------------------	-----------------------------------------	------------------



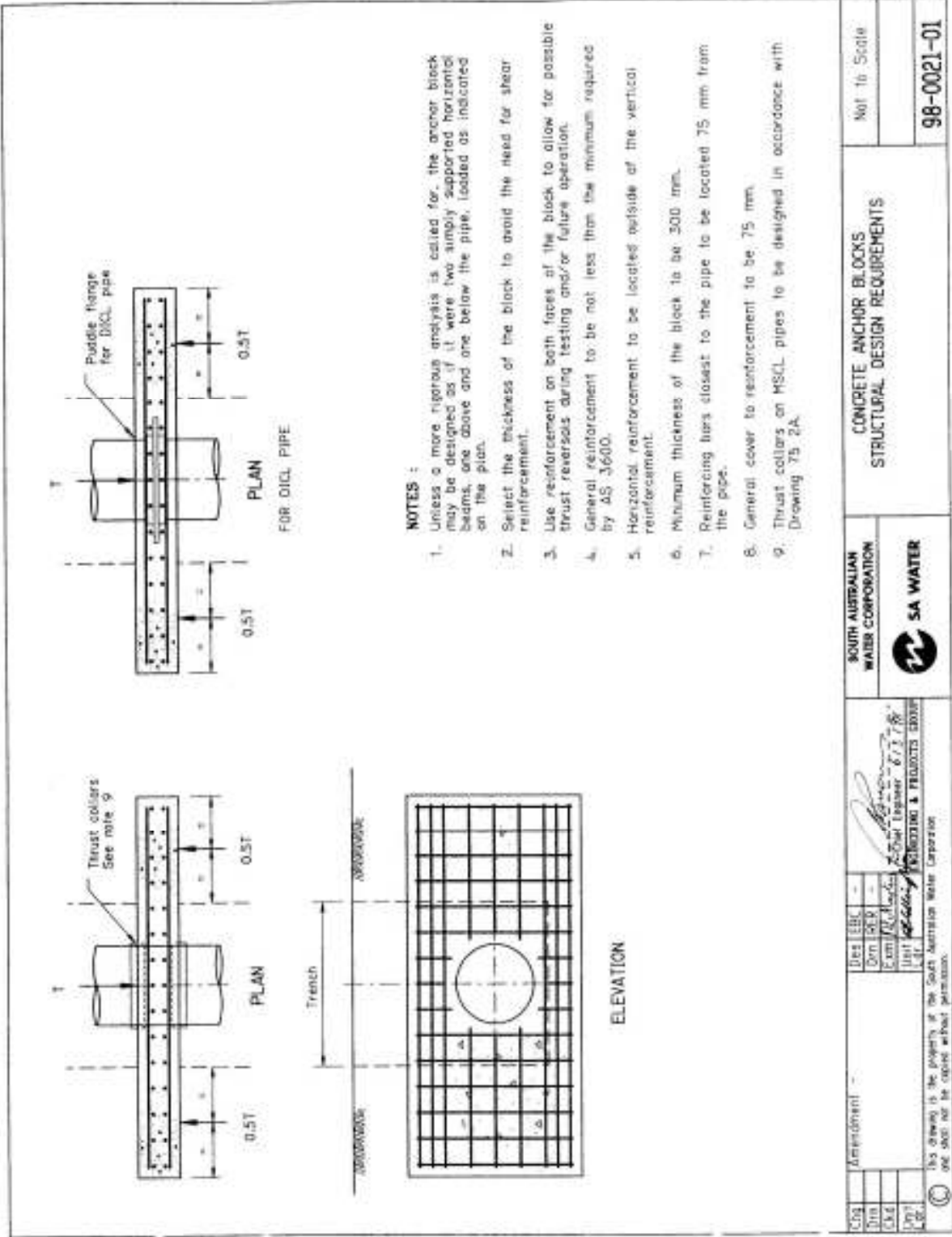

- NOTES :**
1. Unless a more rigorous analysis is called for, the anchor block may be designed as if it were two simply supported horizontal beams, one above and one below the pipe, loaded as indicated on the plan.
  2. Select the thickness of the block to avoid the need for shear reinforcement.
  3. Use reinforcement on both faces of the block to allow for possible thrust reversals during testing and/or future operation.
  4. General reinforcement to be not less than the minimum required by AS 3600.
  5. Horizontal reinforcement to be located outside of the vertical reinforcement.
  6. Minimum thickness of the block to be 300 mm.
  7. Reinforcing bars closest to the pipe to be located 75 mm from the pipe.
  8. General cover to reinforcement to be 75 mm.
  9. Thrust collars on MSCL pipes to be designed in accordance with Drawing Y5 2A.

SOUTH AUSTRALIAN WATER CORPORATION			CONCRETE ANCHOR BLOCKS STRUCTURAL DESIGN REQUIREMENTS			Not to Scale		
SA WATER			SA WATER			98-0021-01		
Amendment - Disc/EBC - Con/Dep - Cam/PLA/Sec - Unit/PLA/Sec - Unit/PLA/Sec -			6/1/2007 6/1/2007 6/1/2007 6/1/2007 6/1/2007 6/1/2007			[Signature] Structural Engineer 6/1/2007 CONSULTING ENGINEERING & PRODUCTS GROUP		
This drawing is the property of the South Australian Water Corporation and shall not be copied without permission.								

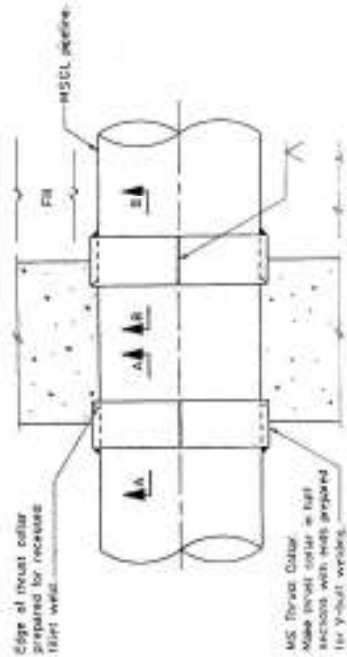

Pipe plate thickness (up to and including)	Collar width	Collar thickness	Weld size
1	W	1	A
5	60	12	B
8	75	16	C
9	200	20	D
10	250	25	E
Over 10	250	25	F

**DESIGN GUIDE**

- The type of collar is used where a concrete wall retains axial thrust from longitudinal pipeline forces.
- Base of design. The concrete stress at the thrust face is limited to 3 MPa. For investigation results see report by J.B. Osborne R 75.
- Applications.
  - Expansion Bed and Below Ground Rigid Height Suitable for all diameter pipelines (maximum collar thickness for these options is 20mm).
  - At Above Ground Rigid Height.
    - Not suitable for pipelines above 600mm diameter. Special design requirements.
    - Where pipelines taper down and thrust collars are installed on smaller pipe, the thrust collar design is generally based on the plate thickness of the larger pipe.

**EN5 500774**  
 Collars are fabricated from the equivalent tube (see our Departmental website)  
 All welding to be done in accordance with AS 1554 Part 1 (Category 3P)

Apply Oxy-Acetylene in accordance with Departmental Specification DS 28. Exposed 50mm min. area concrete surface.

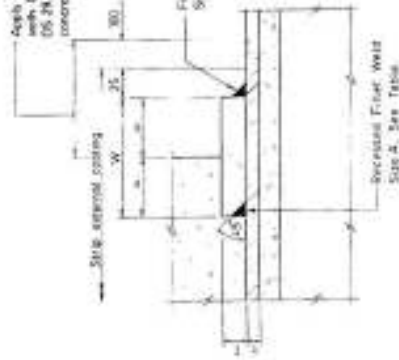

SECTION B-B  
 BELOW GROUND INSTALLATION

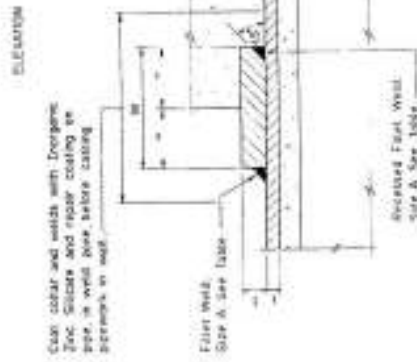

SECTION A-A  
 ABOVE GROUND INSTALLATION

THIS DRAWING SUPERSEDES DRG 75 2

ALL DIMENSIONS ARE IN MILLIMETRES

Des: CDH Dwn: RB Ckd: JMB Scr: JMB	SOUTH AUSTRALIAN GOVERNMENT THE ENGINEERING & WATER SUPPLY DEPARTMENT STANDARD THRUST COLLARS FOR MSCL PIPELINES	Not to scale	75 2A
Approved to Eng 75 2. Reference to Code for External removal Section A-A and B-B headings altered.	Date: / /	Alt: Ckt: Scr: Wks: Ltr:	Date: / /